



INFILTRATOR®
water technologies

Quick4^{PLUS}
CHAMBER SYSTEMS™

The Quick4[®] Plus Standard Chamber

Quick4 Plus™ Series

The Quick4 Plus Standard Chamber offers maximum strength through its two center structural columns. This chamber can be installed in a 36-inch-wide trench. Like the original line of Quick4 chambers, it offers advanced contouring capability with its Contour Swivel Connection™ which permits turns up to 15-degrees, right or left. It is also available in four-foot lengths to provide optimal installation flexibility. The Quick4 Plus All-in-One 12 Endcap, and the Quick4 Periscope are available with this chamber, providing increased flexibility in system configurations.



Maximum Strength

Quick4 Plus Standard Chamber Specifications

Size
34"W x 53"L x 12"H
(864 mm x 1346 mm x 305 mm)

Effective Length
48" (1219 mm)

Louver Height
8" (203 mm)

Storage Capacity
47 gal (178 L)

Invert Height
0.6" (15 mm), 5.3" (135 mm),
8.0" (203 mm), 12.7" (323 mm)

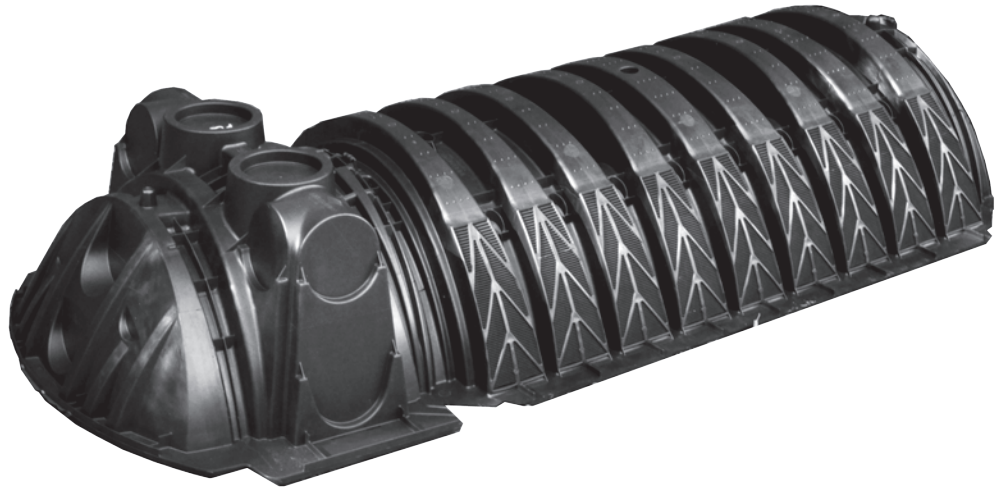

Quick4 Plus Standard Chamber Benefits:

- Two center structural columns offer increased stability and superior strength
- Advanced contouring connections
- Latching mechanism allows for quick installation
- Four-foot chamber lengths are easy to handle and install
- Supports wheel loads of 16,000 lbs/axle with 12" of cover



Quick4 Plus All-in-One 12 Endcap Benefits:

- May be used at the end of chamber row for an inlet/outlet or can be installed mid-trench
- Mid-trench connection feature allows construction of chamber rows with center feed, as an alternative to inletting at the ends of chamber rows
- Center-feed connection allows for easy installation of serial distribution systems
- Pipe connection options include sides, ends or top



Quick4 Plus All-in-One Periscope Benefits:

- Allows for raised invert installations
- 180° directional inletting
- 12" raised invert is ideal for serial applications

APPROVED in _____

Certified by the International Association of Plumbing and Mechanical Officials (IAPMO)



Quick4 Plus Standard Chamber

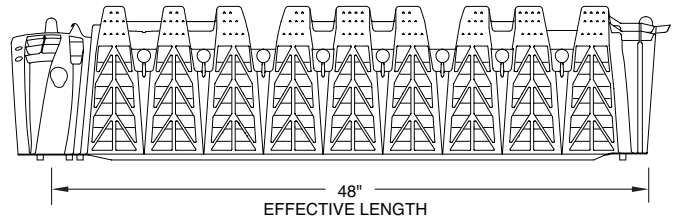
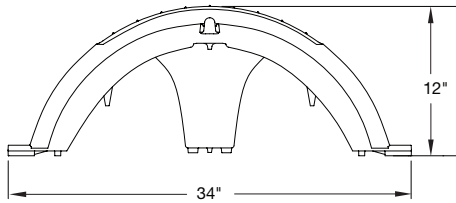

Quick4 Plus All-in-One 12 Endcap

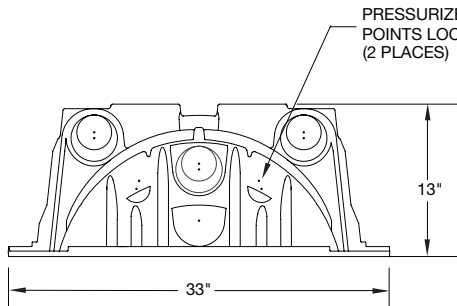

FRONT VIEW

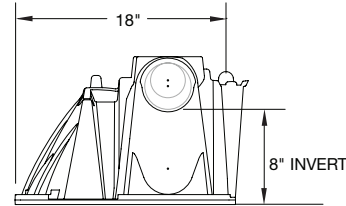

SIDE VIEW

Quick4 Plus All-in-One Periscope

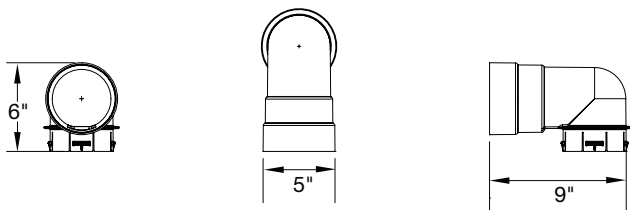
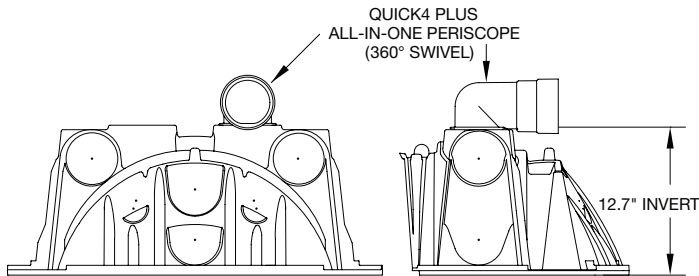

INFILTRATOR WATER TECHNOLOGIES, LLC ("INFILTRATOR")

Infiltrator Water Technologies, LLC STANDARD LIMITED Drainfield WARRANTY

(a) The structural integrity of each chamber, endcap, EZflow expanded polystyrene and/or other accessory manufactured by Infiltrator ("Units"), when installed and operated in a leachfield of an onsite septic system in accordance with Infiltrator's instructions, is warranted to the original purchaser ("Holder") against defective materials and workmanship for one year from the date that the septic permit is issued for the septic system containing the Units; provided, however, that if a septic permit is not required by applicable law, the warranty period will begin upon the date that installation of the septic system commences. To exercise its warranty rights, Holder must notify Infiltrator in writing at its Corporate Headquarters in Old Saybrook, Connecticut within fifteen (15) days of the alleged defect. Infiltrator will supply replacement Units for Units determined by Infiltrator to be covered by this Limited Warranty. Infiltrator's liability specifically excludes the cost of removal and/or installation of the Units.

(b) THE LIMITED WARRANTY AND REMEDIES IN SUBPARAGRAPH (a) ARE EXCLUSIVE. THERE ARE NO OTHER WARRANTIES WITH RESPECT TO THE UNITS, INCLUDING NO IMPLIED WARRANTIES OF MERCHANTABILITY OR FITNESS FOR A PARTICULAR PURPOSE

(c) This Limited Warranty shall be void if any part of the chamber system is manufactured by anyone other than Infiltrator. The Limited Warranty does not extend to incidental, consequential, special or indirect damages. Infiltrator shall not be liable for penalties or liquidated damages, including loss of production and profits, labor and materials, overhead costs, or other losses or expenses incurred by the Holder or any third party. Specifically excluded from Limited Warranty coverage are damage to the Units due to ordinary wear and tear, alteration, accident, misuse, abuse or neglect of the Units; the Units being subjected to vehicle traffic or other conditions which are not permitted by the installation instructions; failure to maintain the minimum ground covers set forth in the installation instructions; the placement of improper materials into the system containing the Units; failure of the Units or the septic system due to improper siting or improper sizing, excessive water usage, improper grease disposal, or improper operation; or any other event not caused by Infiltrator. This Limited Warranty shall be void if the Holder fails to comply with all of the terms set forth in this Limited Warranty. Further, in no event shall Infiltrator be responsible for any loss or damage to the Holder, the Units, or any third party resulting from installation or shipment, or from any product liability claims of Holder or any third party. For this Limited Warranty to apply, the Units must be installed in accordance with all site conditions required by state and local codes; all other applicable laws; and Infiltrator's installation instructions.

(d) No representative of Infiltrator has the authority to change or extend this Limited Warranty. No warranty applies to any party other than the original Holder. The above represents the Standard Limited Warranty offered by Infiltrator. A limited number of states and counties have different warranty requirements. Any purchaser of Units should contact Infiltrator's Corporate Headquarters in Old Saybrook, Connecticut, prior to such purchase, to obtain a copy of the applicable warranty, and should carefully read that warranty prior to the purchase of Units.



4 Business Park Road
P.O. Box 768
Old Saybrook, CT 06475
860-577-7000 • Fax 860-577-7001
1-800-221-4436
www.infiltratorwater.com

U.S. Patents: 4,759,661; 5,017,041; 5,156,488; 5,336,017; 5,401,116; 5,401,459; 5,511,903; 5,716,163; 5,588,778; 5,839,844 Canadian Patents: 1,329,959; 2,004,564 Other patents pending. Infiltrator, Equalizer, Quick4, and SideWinder are registered trademarks of Infiltrator Water Technologies. Infiltrator is a registered trademark in France. Infiltrator Water Technologies is a registered trademark in Mexico. Contour, MicroLeaching, PolyTuff, ChamberSpacer, MultiPort, PosiLock, QuickCut, QuickPlay, SnapLock and StraightLock are trademarks of Infiltrator Water Technologies. PolyLok is a trademark of PolyLok, Inc. TUF-TITE is a registered trademark of TUF-TITE, INC. Ultra-Rib is a trademark of IPEX Inc.

© 2016 Infiltrator Water Technologies, LLC. All rights reserved. Printed in U.S.A.

PLUS05 0816

Contact Infiltrator Water Technologies' Technical Services Department for assistance at 1-800-221-4436